

Assembly of Level Railing

SERIES
600

Contents of Series 600:

4 ft. Railing Package

- A-(1) Top Rail
- B-(1) Bottom Rail
- C-(11) Pickets
- D-(11) Kit - Picket Hardware
- E-(2) Bottom Rail End Brkts.
- F-(2) Top Rail End Brackets
- H-(4) #8 Binding Bolts
(2)1-1/4" & (2)15/16" Lg.
- I-(12) Self-Tapping Screws

Contents of Series 600:

6 ft. Railing Package

- A-(1) Top Rail
- B-(1) Bottom Rail
- C-(18) Pickets
- D-(18) Kit - Picket Hardware
- E-(2) Bottom Rail End Brkts.
- F-(2) Top Rail End Brackets
- H-(4) #8 Binding Bolts
(2)1-1/4" & (2)15/16" Lg.
- I-(12) Self-Tapping Screws

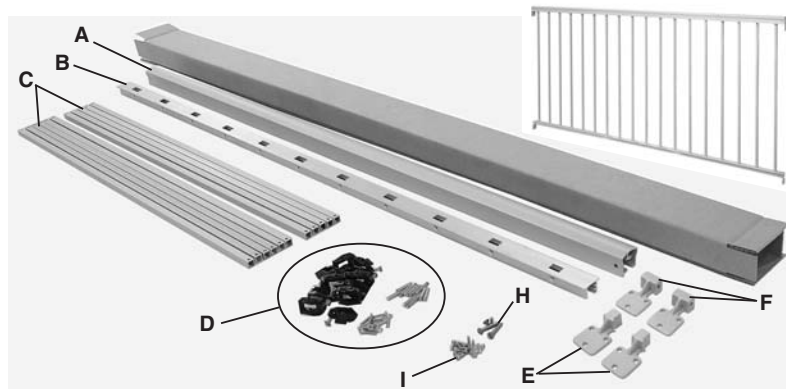

CAUTION Before performing any work, be sure to refer to and follow all standard industry safety precautions. In addition, Superior Aluminum Products, Inc. recommends that all installers wear appropriate protective items, such as safety glasses, work gloves, and steel toed shoes, whenever performing work on Superior Aluminum's Products.

Tools Required: Tape Measure, Battery Operated Drill with adjustable torque clutch, Phillips and Flathead Screwdriver Bits, 1/8" and 13/64" twist drill Bits, (Hacksaw or Cutoff Saw-if required), Hammer, Small Square and Pencil.

Assembly of Railing Section



Step 1. Position bottom rail against top rail and align ends so they are flush with each other. With a pencil draw a line on top rail, just above each hole of the bottom rail.

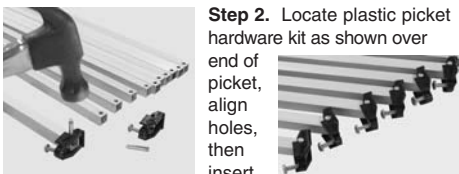

Step 2. Locate plastic picket hardware kit as shown over end of picket, align holes, then insert

chamfered end of kit pin through picket. Lightly drive kit pin in so it is centered in place. Follow same procedure on all pickets.

Step 3. Locate and slide all pickets into top rail. Make sure that the factory installed #8 x 3/4" stainless steel screw in picket hardware kit is located on the same side of picket as each picket is slid into place.



Step 4. Center each picket to pencil mark on top rail. **Do Not** tighten stainless steel screws at this time.

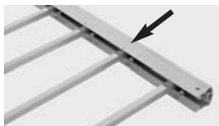

Step 5. Locate end picket in end square hole in bottom rail. Drop in aluminum flathead phillips picket screw when picket hole aligns with bottom rail hole. **Do Not** tighten.



Step 6. With end picket screw in place, ease the next picket in square hole (gradually one at a time) until all pickets are in place.



Step 7. After the last picket is in place, insert and hand tighten the end picket screw to keep assembly together.



Step 8. Position all Phillips head aluminum picket hardware kit screws in bottom rails.

Step 9. With all picket screws in place, tighten all screws. Use a clutch controlled drill. **Do Not** overtighten and strip threads.



Step 10. With a battery operated adjustable clutch drill, turn stainless steel screw so point of screw bears against flat inside surface of top rail. The reason for this is to hold the picket in place at the pencil marked line on the top rail. Set the drill clutch at a low torque setting and low speed to prevent over tightening of component parts.



Shortening a Railing Section (If Required)

Be sure to wear Safety Glasses

When shortening a railing section, it is imperative that the gap between last picket and post is less than 4".

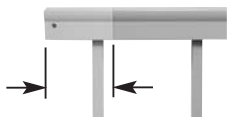

Use a hacksaw or a cut off saw. Remove any burrs from sawcut. **Important: Do Not** discard cut-off section, since the pre-drilled hole locations can be used as a new hole location alignment guide.

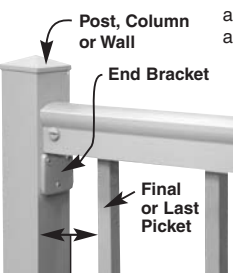

Gap less than 4"

Step 11. Insert top rail end bracket into top rail. **Note:** If railing section was shortened, it will be necessary to drill a new hole in the top rail. Use the cut off section as a guide for the new hole location.



Step 12. Use a 13/64" diameter drill to align holes in end bracket to holes in top rail.



Step 13. Insert a 1-1/4" long, slotted truss head #8 female binder bolt. Turn male binder bolt screw into female binder bolt and tighten to secure assembly together. Follow the same procedure on opposite end of top rail.

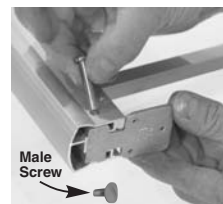

Step 14. Insert bottom rail end bracket into bottom rail. **Note:** If railing section was shortened it will be necessary to drill a new hole in the bottom rail. Use the cut off section as a guide for the hole location.



Step 15. Use a 13/64" diameter drill to align holes in end bracket to holes in bottom rail, as shown in Step 12. Insert a 15/16" long, Phillips truss head #8 female binder bolt, through the bottom rail and end bracket. Secure the assembly together by inserting and tightening a male screw into end of binder bolt.

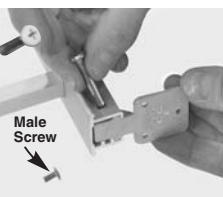

Optional Horizontal Swivels

Turn self-tapping #8 x 3/4" lg. screw into drilled hole in protruding tang. Slide top and bottom horizontal rail swivel bracket into corresponding top or bottom rail. With swivel brackets in place, tighten screw so it spreads the two protruding tangs apart locking the swivel bracket to the bottom rail.

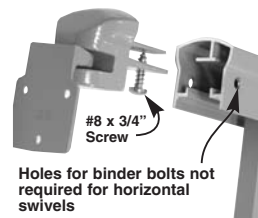

Holes for binder bolts not required for horizontal swivels



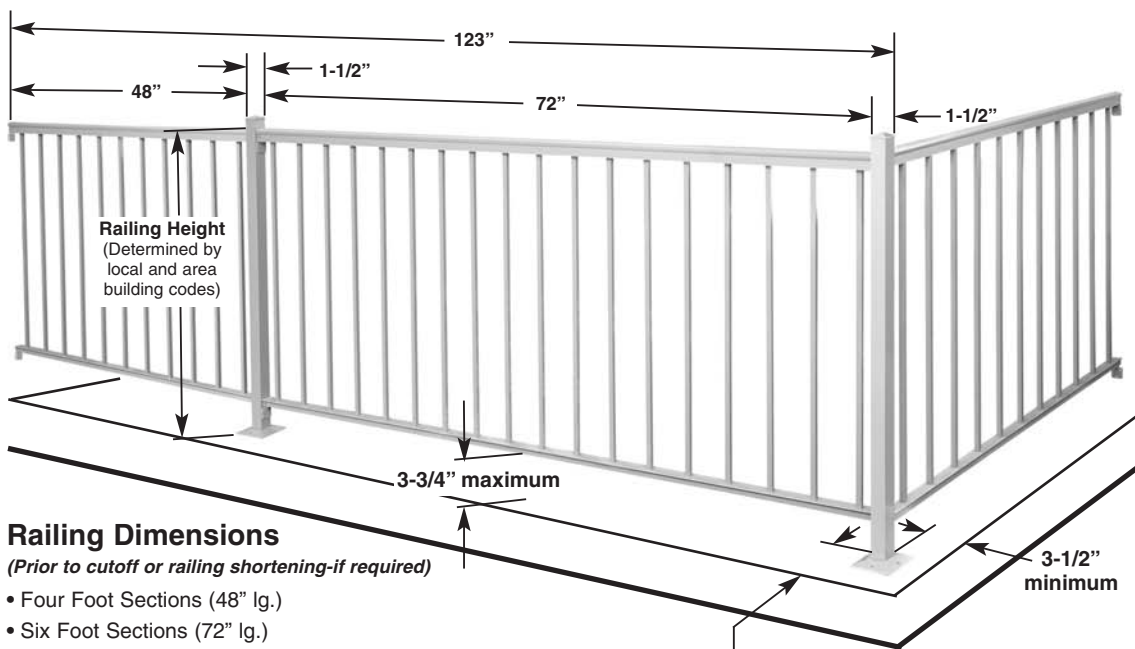

Railing Dimensions

(Prior to cutoff or railing shortening-if required)

- Four Foot Sections (48" lg.)
- Six Foot Sections (72" lg.)
- Square Post (1-1/2" sq.)
- *Optional-Wall Plate (1/4" thick)
- *Optional-Adjustable End Fittings (for top & bottom Rail - 1/4" thick)

*Be sure to subtract 1/4" from total railing installation length when using optional mounting parts on a section end, such as: (Wall Plate or Adjustable End Fittings)

Optional Scrolls



Snap onto picket.
Secure with aluminum screws or aluminum rivets.

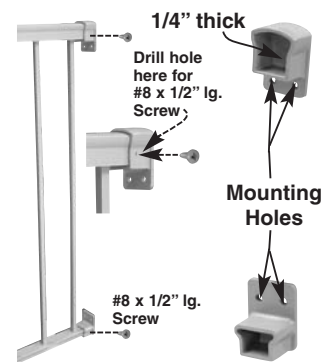

Determining Railing Height

The Railing Height or distance measured from floor to top of top rail surface is determined by **your local area building codes**. For example: A building code that requires a 36" high railing (top rail height), means that a total of 36" (inches) is required from floor (ground) to top rail surface.

The bottom rail distance above ground (or floor) is 3-3/4" maximum.

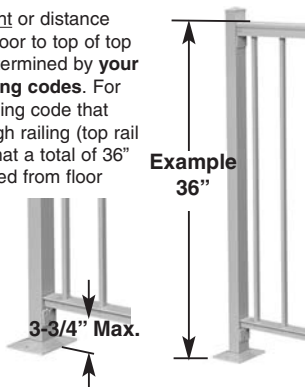

Step 3. Drill 1/8" holes in post for mounting location of top and bottom rails.



Step 4. To secure the end bracket to the post use (3) #8 x 1/2" stainless steel self-tapping screws (furnished) for each end bracket. Follow same procedure for the remaining three rail section ends.

Installation Tip: Note that a 6" shaft extension fitted to the phillips screwdriver bit aids in the job and helps to prevent scratching the paint.



Optional Adj. End Fittings

Attaching Adjustable End Fittings to Building Structure

Locate and slide the top rail adjustable end fitting onto top rail. Next position and slide the bottom rail adjustable end fitting onto the bottom rail. Using a 1/8" diameter drill bit, drill a hole through one side of top and bottom adjustable end fittings and through associated top and bottom rails. Then secure adj. end fittings to rails with a #8 x 1/2" lg. self-tapping screw. Each adjustable fitting has two mounting holes for inserting 1/4" diameter stainless steel screws to secure the railing section to the building structure. **CHECK APPLICABLE STATE, LOCAL, AND FEDERAL BUILDING CODES FOR SPECIFIC FASTENING REQUIREMENTS APPLICABLE TO THE PROJECT.**

Attaching Railing to Post and Floor

Step 1. Cut several wood spacers to prop up the railing so the top rail is at the required building code height.

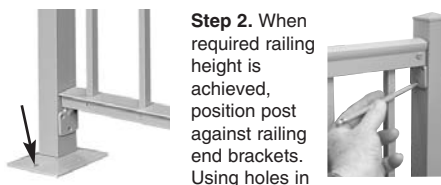

Step 2. When required railing height is achieved, position post against railing end brackets. Using holes in

end brackets as a template, mark each mounting hole location. Mark the hole locations at top, bottom and on each rail section end. See "Note" below.
Note: Before pencil marking end bracket mounting holes on post, check that **post base mounting holes** are facing in opposite directions to railing sections as shown in above photo at left. The reason for this is that it is easier to install post base mounting bolts. Dis-regard this "Note" for railing corner post.

Step 5. Straight and corner sections can be pre-assembled together, prior to attaching to platform or ground level.



Step 6. Locate assembled posts and railing onto final mounting position. Use the 2 post base holes as a template and mark mounting holes on platform or floor surface.

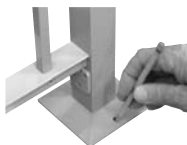

Step 7. The hole to be drilled into the mounting platform should be angled, so it is approximately perpendicular to, (or 90 degrees to) the angled, sloped post base. The diameter of the fastener used must be a minimum of 5/16". The exposed fastener and washer should be stainless steel. Two drilled holes (one on opposite sides) are required for each post. **CHECK APPLICABLE STATE, LOCAL AND FEDERAL BUILDING CODES FOR SPECIFIC FASTENING REQUIREMENTS APPLICABLE TO THE PROJECT.**

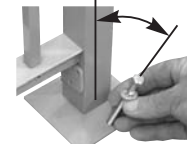

Optional Wall Plate

Attaching Wall Plate to Building Structure

The wall plate is commonly used to secure railing sections to brick, stone or masonry wall structures. It allows for locating and drilling mounting holes at mortar joints. Refer to steps below for attaching wall plates.

Step 1. Mark mounting holes on wall plate using each end bracket as a template.
Step 2. Drill 1/8" holes through wall plate.
Step 3. Attach wall plate to end brackets using (3) #8 x 1/2" lg. stainless steel screws.
Step 4. Grind or saw off any protruding screw ends.
Step 5. Drill (2) 9/32" holes through wall plate at mortar joint locations.
Step 6. Insert and tighten screws to secure railing section to wall. **CHECK APPLICABLE STATE, LOCAL, AND FEDERAL BUILDING CODES FOR SPECIFIC FASTENING REQUIREMENTS APPLICABLE TO THE PROJECT.**

Example view of drilled mounting holes at mortar joints

